

Invacare® Birdie® EVO

Birdie® EVO XPLUS



en **Mobile Patient Lift
User Manual**



This manual **MUST** be given to the user of the product.
BEFORE using this product, this manual **MUST** be read and saved
for future reference.



Yes, you can.®

©2021 Invacare Corporation

All rights reserved. Republication, duplication or modification in whole or in part is prohibited without prior written permission from Invacare. Trademarks are identified by ™ and ®. All trademarks are owned by or licensed to Invacare Corporation or its subsidiaries unless otherwise noted.

Making Life's Experiences Possible is a registered trademark in the U.S.A.

Contents

1 General	4	9 After Use	25
1.1 Introduction	4	9.1 Disposal	25
1.1.1 Symbols in this Document	4	9.2 Reconditioning	25
1.2 Service Life	4	10 Troubleshooting	26
1.2.1 Additional information	4	10.1 Identifying faults and possible solutions	26
1.3 Limitation of Liability	4	11 Technical Data	27
1.4 Warranty Information	4	11.1 Maximum safe working load	27
1.5 Compliance	4	11.2 Dimensions and Weights	27
1.5.1 Product-specific standards	4	11.3 Electrical System	28
2 Safety	5	11.4 Environmental Conditions	29
2.1 General safety information	5	11.5 Materials	29
2.1.1 Pinch points	5	11.6 Operating Forces of Controls	29
2.2 Safety Information on Accessories	6	12 Electromagnetic compatibility (EMC)	30
2.3 Safety information on electromagnetic interference	6	12.1 General EMC information	30
2.4 Labels and symbols on the product	7	12.2 Electromagnetic emission	30
2.4.1 Label Location	7	12.3 Electromagnetic Immunity	30
2.4.2 Identification label	7		
2.4.3 Other Labels and Symbols	7		
3 Product Overview	9		
3.1 Intended use	9		
3.2 Compatible Slings	9		
3.3 Main parts of the lift	9		
3.4 Accessories	9		
4 Setup	10		
4.1 General safety information	10		
4.2 Scope of delivery	10		
4.3 Installing the mast	10		
4.3.1 Unfolding the mast	10		
4.4 Unfolding the spreader bar	11		
4.5 Installing the actuator to the boom	12		
4.6 Resetting the service indicator	12		
5 Usage	13		
5.1 General safety information	13		
5.2 Locking/Unlocking the Rear Castors	13		
5.3 Raising/Lowering an Electric Lift	13		
5.4 Closing/Opening Legs	13		
5.4.1 Closing/Opening Electric Legs	13		
5.5 Emergency functions	13		
5.5.1 Performing an emergency stop	13		
5.5.2 Activating an emergency lowering (CBJ Care control unit)	13		
5.5.3 Activating an Emergency Lifting (CBJ Care control unit)	14		
5.5.4 Activating a mechanical emergency lowering	14		
5.6 Charging the battery	14		
6 Patient Transfer	16		
6.1 General safety information	16		
6.2 Preparing to lift	16		
6.2.1 Attaching the sling to the lift	17		
6.3 Transferring a patient from a bed	17		
6.4 Transferring a patient to a bed	18		
6.5 Transferring a patient from a wheelchair	19		
6.6 Transferring a patient to a wheelchair	19		
6.7 Transferring a patient to and from a commode	19		
6.8 Lifting a patient from the floor	20		
7 Transportation and Storage	22		
7.1 General information	22		
7.2 Folding the mast	22		
8 Maintenance	23		
8.1 General maintenance information	23		
8.2 Daily inspections	23		
8.3 Cleaning and Disinfection	23		
8.3.1 General safety information	23		
8.3.2 Cleaning Intervals	23		
8.3.3 Cleaning instructions	23		
8.3.4 Disinfection Instructions	24		
8.4 Service interval	24		

1 General

1.1 Introduction

This user manual contains important information about the handling of the product. To ensure safety when using the product, read the user manual carefully and follow the safety instructions.

Note that there may be sections in this document, which are not relevant to your product, since this document applies to all available models (on the date of printing). If not otherwise stated, each section in this document refers to all models of the product.

The models and configurations available in your country can be found in the country-specific sales documents.

Invacare reserves the right to alter product specifications without further notice.

Before reading this document, make sure you have the latest version. You find the latest version as a PDF on the Invacare website.

If you find that the font size in the printed document is difficult to read, you can download the PDF version from the website. The PDF can then be scaled on screen to a font size that is more comfortable for you.

For more information about the product, for example product safety notices and product recalls, contact your Invacare distributor. See addresses at the end of this document.

In case of a serious incident with the product, you should inform the manufacturer and the competent authority in your country.

1.1.1 Symbols in this Document

Symbols and signal words are used in this document and apply to hazards or unsafe practices which could result in personal injury or property damage. See the information below for definitions of the signal words.



WARNING

Indicates a hazardous situation that could result in serious injury or death if it is not avoided.



CAUTION

Indicates a hazardous situation that could result in minor or slight injury if it is not avoided.



IMPORTANT

Indicates a hazardous situation that could result in damage to property if it is not avoided.



Tips and Recommendations

Gives useful tips, recommendations and information for efficient, trouble-free use.

1.2 Service Life

The expected service life of this product is eight years when used daily and in accordance with the safety instructions,

maintenance intervals and correct use, stated in this manual. The effective service life can vary according to frequency and intensity of use.

1.2.1 Additional information

The expected service life is based on an estimated average of 4 lifting cycles per day.

1.3 Limitation of Liability

Invacare accepts no liability for damage arising from:

- Non-compliance with the user manual
- Incorrect use
- Natural wear and tear
- Incorrect assembly or set-up by the purchaser or a third party
- Technical modifications
- Unauthorised modifications and/or use of unsuitable spare parts

1.4 Warranty Information

We provide a manufacturer's warranty for the product in accordance with our General Terms and Conditions of Business in the respective countries.

Warranty claims can only be made through the provider from whom the product was obtained.

1.5 Compliance

Quality is fundamental to the company's operation, working within the disciplines of ISO 13485.

This product features the CE mark, in compliance with the Medical Device Regulation 2017/745 Class I. The launch date of this product is stated in the CE declaration of conformity.

We are continuously working towards ensuring that the company's impact on the environment, locally and globally, is reduced to a minimum.

We only use REACH compliant materials and components.

We comply with the current environmental legislations WEEE and RoHS.

1.5.1 Product-specific standards

The product has been tested and conforms to ISO 10535 (Hoists for the transfer of disabled persons) and all related standards.

For further information about local standards and regulations, contact your local Invacare representative. See addresses at the end of this document.

2 Safety

2.1 General safety information

This section of the manual contains general safety information about your product. For specific safety information, refer to the appropriate section of the manual and procedures within that section.



WARNING!

Risk of injury or damage

- Do not use this product or any available optional equipment without first completely reading and understanding these instructions and any additional instructional material such as user manuals or instruction sheets supplied with this product or optional equipment. If you are unable to understand the warnings, cautions or instructions, contact a healthcare professional, Invacare provider or qualified technician before attempting to use this product.
- Do not make any unauthorized alterations or modifications to the product.



WARNING!

The maximum safe working load must not be exceeded

- Do not exceed the maximum safe working load of this product or used accessories like slings, spreader bars etc. See documentation or the labeling for the stated maximum safe working load.
- The component with the lowest load limit determines the maximum safe working load of the entire system.



WARNING!

Risk of injury or damage

- Improper use of this product may cause injury or damage.
- Do not attempt any transfer without approval of the patient's healthcare professional.
 - Read the instructions in this user manual and observe trained personnel performing transfer procedures. Then practice transfers under supervision and with a capable person acting as a patient.
 - Special care must be taken with people with disabilities who cannot cooperate while being transferred.
 - Do not use the lift as a transport device. It is intended to transfer an individual from one resting surface to another.



WARNING!

Risk of injury or damage

- Inappropriate handling of cables can cause electrical shock and product failure.
- Do not kink, shear or otherwise damage the cables of the product.
 - Make sure that no cables are jammed or damaged, when the product is used.
 - Make sure the wiring is correct and connections are proper.
 - Do not use unauthorized equipment.



WARNING!

Risk of injury or damage

- Excessive moisture will damage the product and may cause electrical shock.
- The patient lift can be used in a bath or shower area but must NOT be used under the shower. The patient must be transferred to a shower chair or use other means for showering.
 - If the patient lift is used in a moisture environment, ensure that the patient lift is wiped clean of any moisture after use.
 - Do not plug or unplug the power cable in a moisture environment or with wet hands.
 - Do not store the product in a damp area or damp condition.
 - Periodically inspect all components of the product for signs of corrosion or damage. Replace parts that are corroded or damaged.
 - See *Environmental conditions*.



WARNING!

Risk of injury or damage

- Ignition sources can cause burns or fire.
- Patient transfer must be performed with a safety space between the lift and possible ignition sources (heater, stove, fireplace, etc.)
 - The patient and assistants must not smoke during transfer.
 - The sling must not be placed over heat sources (heater, stove, fireplace, etc.)



WARNING!

Risk of injury or damage

- To avoid injury or damage when operating the product:
- Close supervision is necessary when the product is used near children or pets.
 - Do not let children play with the product.



CAUTION!

Risk of injury or damage

- The product can get hot when exposed to sunlight or other heat sources.
- Do not expose the product to direct sunlight for prolonged periods.
 - Keep the product away from heat sources.

IMPORTANT!

- Accumulation of lint, dust and other dirt can impair the product.
- Keep the product clean.

2.1.1 Pinch points

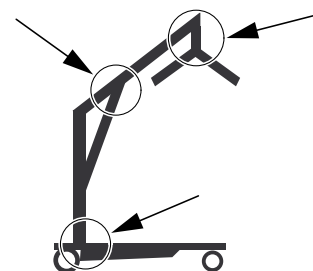

**WARNING!****Risk of Injury**

Pinch points are present in several locations on the lift and fingers could be pinched.

- Always keep hands and fingers clear of moving parts.

2.2 Safety Information on Accessories

**CAUTION!****Risk of Injury**

Non-original or incorrect accessories may affect the function and safety of this product.

- Due to regional differences, refer to your local Invacare website or catalog for available accessories or contact your Invacare provider.
- See the manual delivered with the accessory for further information and instructions.
- Use only original accessories for the product in use. Under certain circumstances, the use of slings from other manufacturers is possible. See additional information in this section.

**CAUTION!****Compatibility of Slings with Attachment System**

Invacare products are specifically designed and manufactured for use in conjunction with Invacare accessories. Accessories designed by other manufacturers have not been tested by Invacare and are not recommended for use with Invacare products. Invacare uses a common attachment system based on hooks and loops. Loops on the slings are attached to hooks on spreader bars (coat hanger style).

- Use only the recommended Invacare slings with loop attachments that are suitable for spreader bars (coat hanger style) with hooks.
- Do not use slings designed for "Keyhole or Clip Attachment Systems" or "Tilting Frame Systems".

To select the appropriate sling, a risk assessment must be performed by a healthcare professional. The risk assessment must consider:

- The patient's weight, size, physical ability and medical condition.

- The type of transfer and the environment.
- The compatibility to the other lifting equipment used.

2.3 Safety information on electromagnetic interference

**WARNING!****Risk of malfunction due to electromagnetic interference**

Electromagnetic interference between this product and other electrical equipment can occur and disturb the electrical adjustment functions of this product. To prevent, reduce or eliminate such electromagnetic interference:

- Only use original cables, accessories and spare parts, to not increase electromagnetic emission or reduce electromagnetic immunity of this product.
- Do not use portable radio frequency (RF) communications equipment closer than 30 cm to any part of this product (including cables).
- Do not use this product near active high-frequency surgical equipment and the RF shielded room of a system for magnetic resonance imaging, where the intensity of electromagnetic disturbances is high.
- If disturbances occur, increase the distance between this product and the other equipment or switch it off.
- Refer to the detailed information and follow the guidance in chapter 12 *Electromagnetic compatibility (EMC)*, page 30.

**WARNING!****Risk of malfunction**

Electromagnetic interference may cause improper operation.

- Do not use this product adjacent to or stacked with other electrical equipment. If such use is necessary this product and the other equipment must be closely observed to verify that they are operating normally.

2.4 Labels and symbols on the product

2.4.1 Label Location

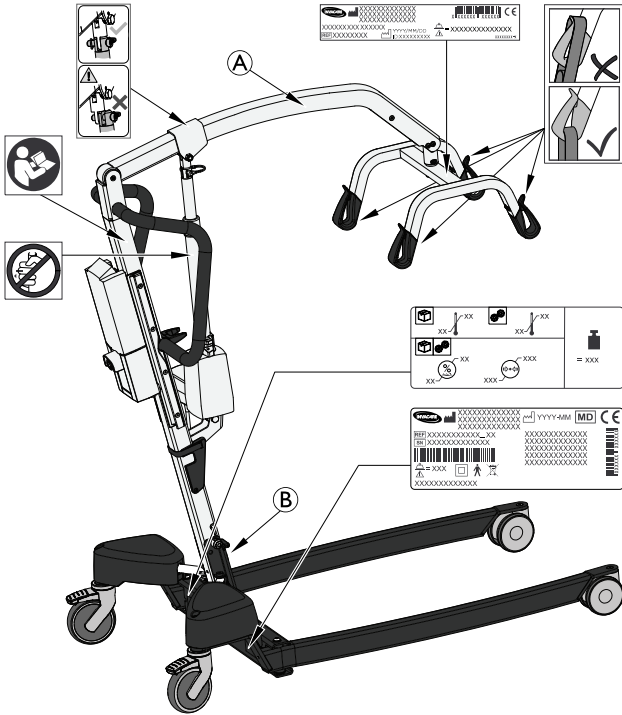

Ⓐ	Lift's Name and Safe Working Load
Ⓑ	Lift's Safe Working Load

For more information on the labels see the following information.

2.4.2 Identification label



The identification label contains the main product information, including technical data.

Symbols

	Serial number
	Reference number
	Manufacturer
	Date of manufacture
	Max. safe working load

	Class II equipment
	Type B applied part
	WEEE conform
	European Conformity
	Medical device

Abbreviations for technical data:

- lin = Incoming Current
- Uin = Incoming Voltage
- Int. = Intermittence
- AC = Alternating Current
- Max = maximum
- min = minute

For more information about technical data, see 11 Technical Data, page 27.





2.4.3 Other Labels and Symbols

Read the user manual before using this product and follow all instructions for safety and use.

Do not apply any side forces to the actuator (e.g. by using it as a push bar) as this might result in damage and malfunction.

Do not remove this label and manipulate the underlying screw as this might impair the safety of the product.
The warranty of the product is voided if this label is removed or broken.

	Total weight of the product with the maximum safe working load applied
	Temperature limit

	Humidity limitation
	Atmospheric pressure limitation
	Transport and storage conditions
	Operation conditions

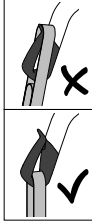
<p>Always ensure that the sling is properly attached to the hooks. See <i>Attaching the sling to the lift</i>.</p>

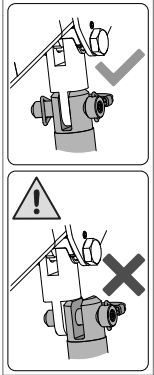
<p>Ensure the mast's actuator is properly attached to the boom's extension piece.</p>

3 Product Overview

3.1 Intended use

The mobile patient lift is a battery-powered transfer device and is intended to transfer and position an individual from one resting surface to another. For example:

- Between the bed and a wheelchair
- To and from the toilet
- Lowering and raising patients to/from the floor

The maximum safe working load is stated in *11 Technical Data, page 27*

The mobile patient lift is designed to be used indoors on a level surface, in hospitals, nursing facilities and domestic areas. The mobile patient lift can be turned (rotated) in place for transfers with limited floor space.

A healthcare professional or private person who has received proper training is the intended operator of this product.

Indications for Use

The mobile patient lift is indicated for completely or partially immobile patients, who cannot be transferred with other types of lifts or transfer aids.

All position changes are possible without assistance of the patient.

There are no known contraindications for this product.

Exemption

PER 21 CFR 801 Subpart C the device is labeled for Over-The-Counter Use only.

3.2 Compatible Slings

The following Invacare Sling models with loop attachments, suitable for spreader bars (coat hanger style) with hooks, are compatible with this product:

- Full Body Sling — with or without Commode Opening
- Comfort Sling — with or without Commode Opening
- Divided Leg Sling
- Universal High Sling
- Easy Fit Sling
- Toileting Sling
- Dress High Toileting Sling
- Heavy-Duty Sling — with or without Commode Opening

3.3 Main parts of the lift

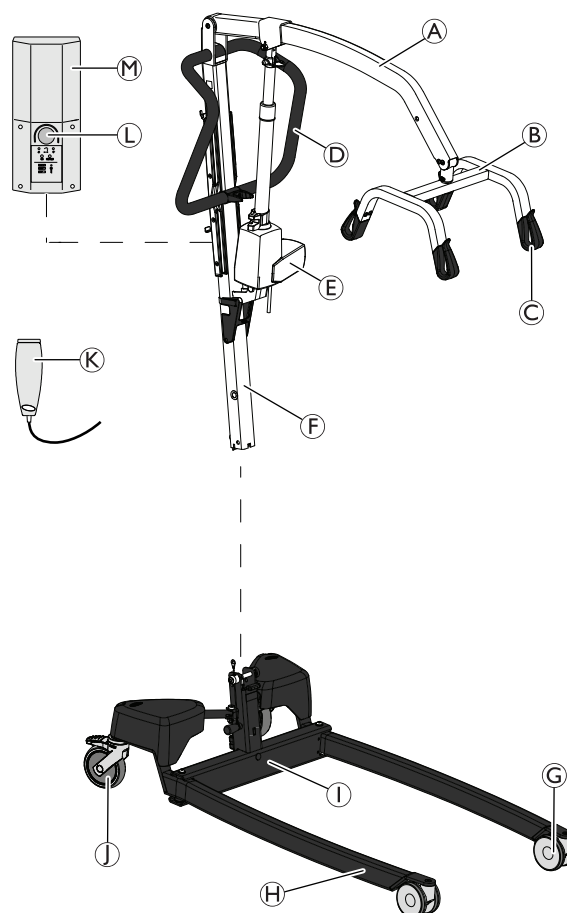

(A)	Boom
(B)	Spreader bar
(C)	Hook for sling
(D)	Push bar
(E)	Lifting actuator
(F)	Foldable Mast
(G)	Front Castors
(H)	Leg
(I)	Base with actuators (and actuator covers) for the electrical leg spreader
(J)	Rear castors with brake
(K)	Hand control
(L)	Emergency Stop
(M)	CBJ Care — control unit with detachable battery

3.4 Accessories

- Wunder® RS300 Scale to be mounted with the spreader bar
- Protective shrouds for legs
- Padding for spreader bar

4 Setup

4.1 General safety information



WARNING!

- Check all parts for shipping damage before use.
- In case of damage, do not use the equipment. Contact your Invacare provider for further instructions.



WARNING!

Risk of Injury

- Improper assembly may cause injury or damage.
- Use only Invacare parts in the assembly of this patient lift.
 - After each assembly, check that all fittings are properly tightened and all parts have the correct function
 - Do not overtighten the mounting hardware. This may damage the mounting brackets.



There are no tools required to assemble the patient lift.

If there are any issues or questions during assembly, contact your Invacare provider.

4.2 Scope of delivery

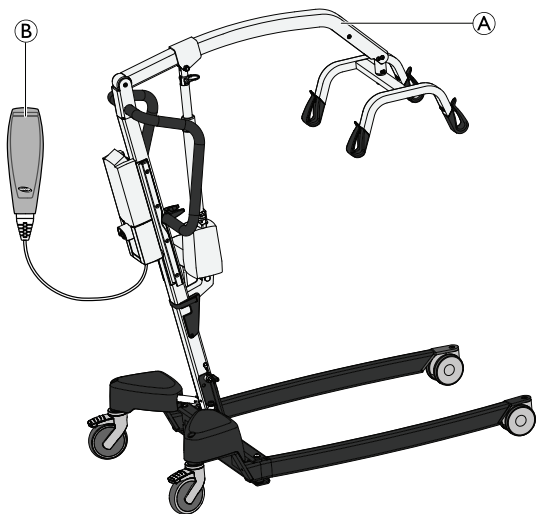

Ⓐ	Lift – incl. base, mast, boom, foldable mast, spreader bar, control unit and actuators (1 unit)
Ⓑ	Hand control (1 unit)
	Battery (2 units)
	Wall Charger for detachable battery (1 unit)
	User Manual (1 unit)

4.3 Installing the mast

4.3.1 Unfolding the mast



WARNING!

- The mast may be folded for storage or transporting. Each time the mast is folded, the mast **MUST** be properly secured to the base assembly.
- Check all parts for visible defects or damage before assembly. In case of any damage, do not use the product and contact your Invacare provider.
- Make sure the emergency stop is activated before assembly or disassembly.
- Take care when lifting components during assembly. Some parts are heavy. Always remember to adopt the correct lifting position.

Perform unpacking and assembly operation at floor level.

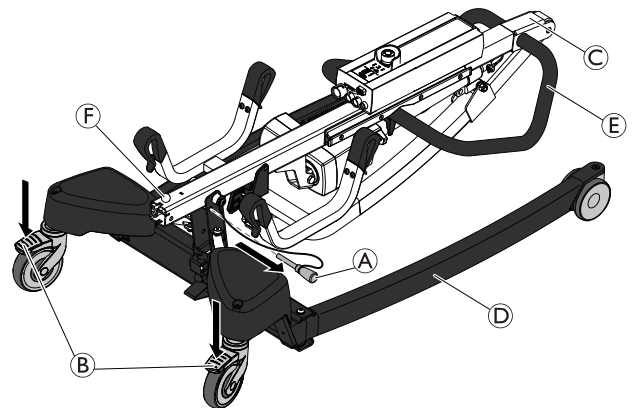

1. Lock both rear castors Ⓑ. Remove the locking pin Ⓐ.
2. Raise the mast assembly Ⓒ to an upright position by stepping with one foot on the leg Ⓓ and pulling the push bar Ⓔ upwards until the safety catch Ⓕ snaps in place.
- 3.

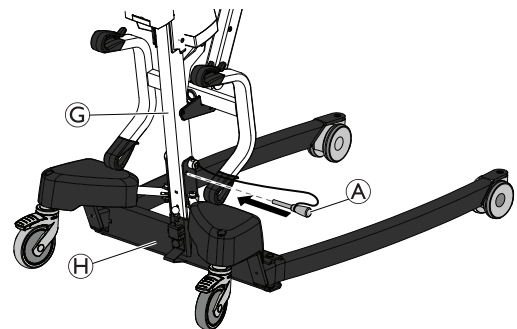

Reinstall the locking pin Ⓐ through the mast Ⓒ and base Ⓓ. Ensure that the locking pin is correctly inserted.

4.4 Unfolding the spreader bar

1.

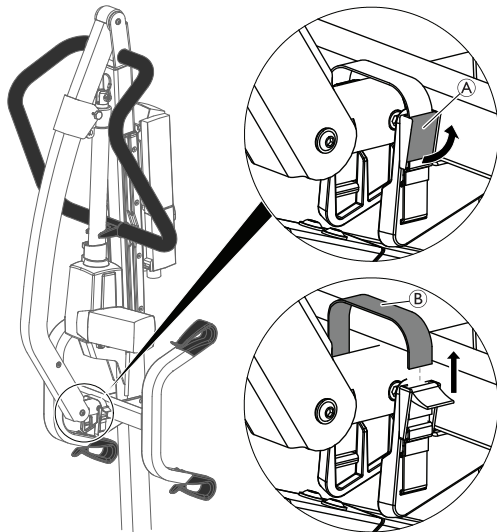

Open the fastener **A** and remove the band **B** from the clamping buckle.

2.

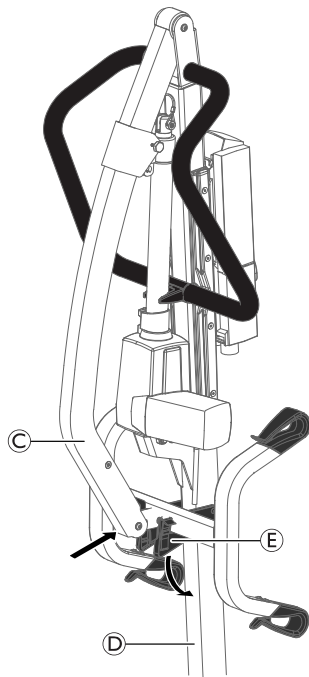

Push and hold the boom **C** towards the mast **D** and fold down the spreader bar holder **E**.

3.

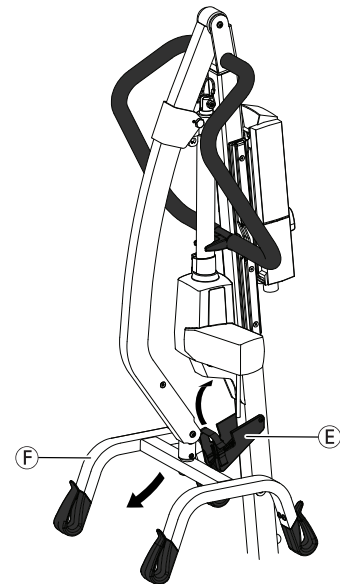

Fold down the spreader bar **F** and fold up the spreader bar holder **E**.

4.

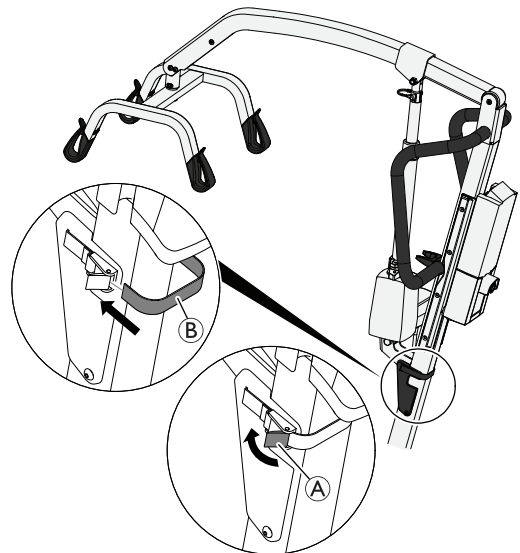

Wrap the band **B** around the back of the mast, insert it into the clamping buckle and close the fastener **A**.

4.5 Installing the actuator to the boom

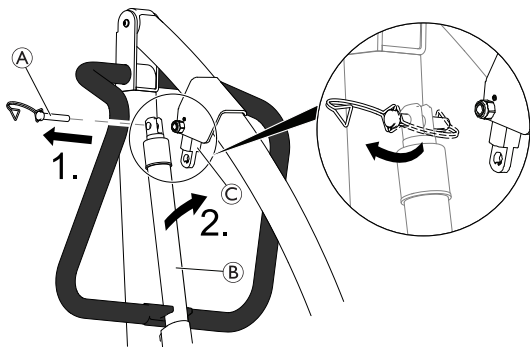

1. Release the D-clip and remove the pin (A) from actuator (B).
2. Remove the actuator (B) from the bracket on the mast and fit it to the boom's extension piece (C).
- 3.

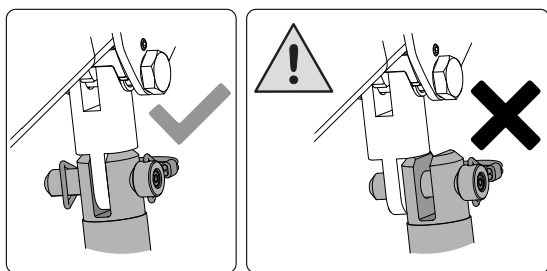
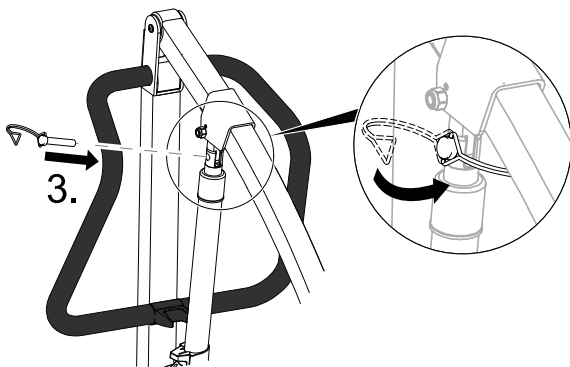

i The pin (A) indent must align with the hole on the extension piece.

Align the holes and reinstall the pin (A). Make sure that the pin is completely inserted and secure it with the D-clip.

4.6 Resetting the service indicator

! **IMPORTANT!**
If the service light is flashing yellow during daily usage or after a reassembly, the lift requires service.
– Contact your Invacare provider for service.

After the initial assembly of the lift, the service indicator needs to be reset before using the lift.

To perform an initial reset of the service indicator:

1. Locate the hand control.
2. Press and hold the UP button and the DOWN button at the same time for five seconds.
3. You will hear a sound when the service indicator has been reset.

5 Usage

5.1 General safety information



WARNING!

Risk of injury or damage

Before using the lift with a patient, refer to the following safety information and instructions:

- 2 Safety, page 5
- 6 Patient Transfer, page 16

5.2 Locking/Unlocking the Rear Castors



WARNING!

Risk of Injury or Damage

The lift could tip and endanger the patient and assistants.

- Invacare recommends that the rear castors be left unlocked during lifting procedures to allow the patient lift to stabilize itself when the patient is initially lifted from a chair, bed or any stationary object.
- Invacare recommends locking the rear castors of the lift only when positioning or removing the sling from around the patient.

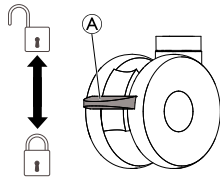

- To lock the castor, push down pedal (A) with the foot.
- To unlock the castor, push up pedal (A) with the foot.

5.3 Raising/Lowering an Electric Lift

The hand control is used to raise or lower the lift.



WARNING!

Risk of Injury or Damage

Damage to parts of the lift (hand control, castors, etc.) caused by impact with walls or other stationary objects may cause damage to the product and lead to injury.

- DO NOT raise the boom manually.
- ALWAYS use the hand control to raise the boom.

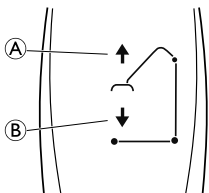

1. To raise the lift — Press and hold the UP (A) button to raise the boom and the patient.
2. To lower the lift — Press and hold the DOWN (B) button to lower the boom and the patient.



Release the button to stop raising or lowering the lift.

5.4 Closing/Opening Legs



WARNING!

Risk of Injury

The lift could tip and endanger the patient and assistants.

- The legs of the lift must be in the maximum open position for optimum stability and safety. If it is necessary to close the legs of the lift to maneuver the lift under a bed, close the legs of the lift only as long as it takes to position the lift over the patient and lift the patient off the surface of the bed. When the legs of the lift are no longer under the bed, return the legs of the lift to the maximum open position.

5.4.1 Closing/Opening Electric Legs

The hand control is used to open or close the legs of the base.

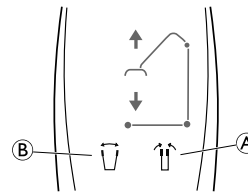

1. To close the legs, press and hold the legs closed button (A).
2. To open the legs, press and hold the legs open button (B).



The legs will stop moving when the button is released.

5.5 Emergency functions

5.5.1 Performing an emergency stop

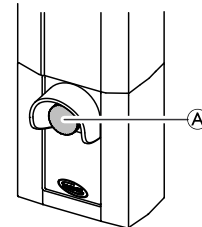

1. Press the red emergency button (A) on the control unit to stop the boom and patient from raising or lowering.
2. To reset, rotate the emergency button clockwise.

5.5.2 Activating an emergency lowering (CBJ Care control unit)

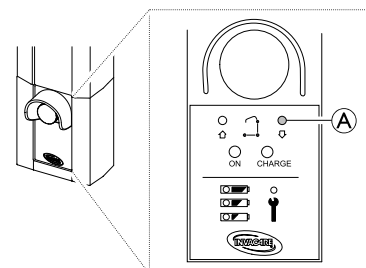

If the hand control fails, the boom can be lowered by using the circular switch for emergency release. Use a sharp object, such as a pencil to press the button.

1. Lower the boom by pressing and holding button Ⓐ at the front of the control unit.
2. Stop lowering the boom by releasing the button.

5.5.3 Activating an Emergency Lifting (CBJ Care control unit)

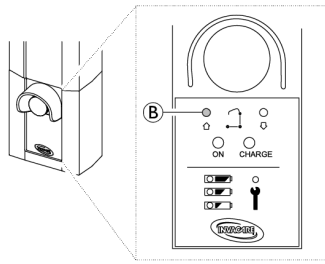

If the hand control fails, the boom can be raised by using the circular switch for emergency lifting. Use a sharp object, such as a pencil to press the button.

1. Raise the boom by pressing and holding button Ⓑ at the front of the control unit.
2. Stop raising the boom by releasing the button.

5.5.4 Activating a mechanical emergency lowering

If the emergency lowering on the control unit is not working, a mechanical emergency lowering is available as a back-up. This may happen in case of partial or total power failure, or if the battery runs down during use.



WARNING!

Risk of Injury or Damage

Repeated mechanical emergency lowering leads to a high increase of the lowering speed.

- Only use the mechanical emergency lowering as a back-up when the emergency lowering on the control unit is not working.
- Do not use the mechanical emergency lowering repeatedly in close succession.
- Always lower the patient onto a supporting surface like a bed or a chair.
- After a mechanical emergency lowering was required, the lift must be checked to resolve the malfunction of the control unit.

Birdie® EVO XPLUS

1. Locate the red emergency grip Ⓐ at the bottom of the actuator piston.
2. Slowly pull up the red emergency grip Ⓐ and hold it in position when a safe lowering speed is reached.
3. If no lowering occurs with a fully pulled emergency grip Ⓐ, push down on the boom at the same time.

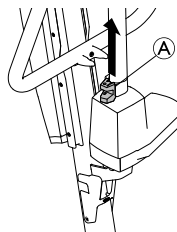

The effective lowering speed is depending on the patient weight. If the speed is too low or too high, it can be adapted to the patient weight.

Adjusting the lowering speed:

1. Locate the screw in the bottom hole of the red emergency grip Ⓐ.
2. Turn the screw counter-clockwise to increase the speed.
3. Turn the screw clockwise to decrease the speed.

5.6 Charging the battery

IMPORTANT!

- Make sure the emergency stop is not activated while charging the battery.
- Make sure that charging takes place in a room with good air ventilation.
- Do not attempt to use the lift if the battery housing is damaged.
- Replace a damaged battery housing before further use.

It is recommended to charge the battery daily to ensure optimal use of the lift and prolong the life of the battery. Furthermore, it is recommended to charge the battery before first use.

CBJ Care Control Unit

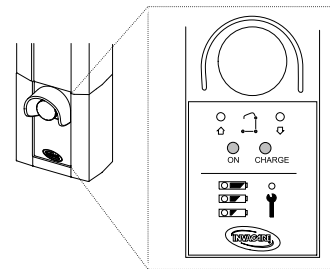

The control unit is equipped with a sound signal. A beep indicates that the battery has low capacity, but lowering the patient is still possible. It is recommended to charge the batteries as soon as the sound signal is heard.

Battery Indicator

The control unit is equipped with a battery indicator Ⓓ, indicating the remaining battery capacity.

Battery Indicator Type	Battery State	Description
	Full Charge	The battery is OK — no need for charging (100–50%). The top LED is GREEN.
	Partial Charge	The battery needs to be charged (50–25%). The middle LED is YELLOW.

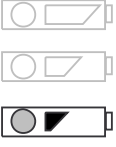
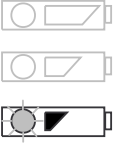
Battery Indicator Type	Battery State	Description
	Low Charge	The battery needs to be charged (Less than 25%). Acoustic signal when a button is pressed. The bottom LED is YELLOW.
	Low Charge (LED flashing)	The battery needs to be charged. Some of the functionality of the lift is lost and it is only possible to lower the boom.

Battery charger

 The procedure of removing or installing the battery is the same for the control unit and the charger.

Removing the battery

1.

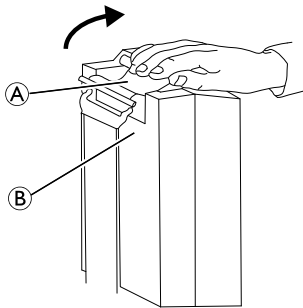

2.

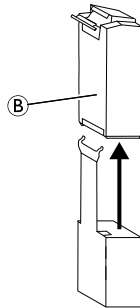

1. Lift up on the handle (A) on the back of the battery (B).
2. Lift the battery up and out away from the control unit or charger .

Installing the battery



CAUTION!

Installing the battery improperly may cause injury or damage.

- Make sure there is an audible click when installing the battery on the control unit or charger to confirm proper installation.

1. Place the battery (B) on the control unit or charger as shown and make sure there is an audible click.

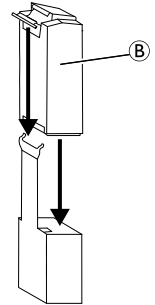

When the battery is placed on the charger, the charge LED will illuminate. When charging is complete, charge LED will switch off.

A battery needing to be fully recharged will take approximately four hours.

6 Patient Transfer

6.1 General safety information



WARNING!

Risk of Injury or Damage

Improper use of this product may cause injury or damage.

- Before transferring to a stationary object (wheelchair, bed, commode or other surface) check that the weight capacity can withstand the patient's weight.
- If applicable the wheel or castor locks of the stationary object (wheelchair, bed etc.) must be in a locked position before lowering the patient onto or lifting the patient off.



WARNING!

Risk of Injury or Damage

Improper use of this product may cause injury or damage.

- Use the push bars on the mast at all times to push or pull the lift.
- Avoid using the lift on an incline. Invacare recommends that the product only be used on a flat surface.
- During transfer, with the patient suspended in a sling attached to the lift, DO NOT roll lift over uneven surfaces that could cause the lift to tip over.



WARNING!

Risk of Injury or Damage

Damage to parts of the lift (hand control, castors, etc.) caused by impact with the floor, walls or other stationary objects may cause damage to the product and lead to injury.

- DO NOT allow parts of the lift to impact the floor, walls or other stationary objects.
- ALWAYS store the hand control properly when not in use.



WARNING!

Risk of Injury

The spreader bar can move suddenly and cause injury.

- When positioning lift, be aware of the position of the spreader bar and the patient.



WARNING!

Risk of Entrapment or Strangulation

The hand control cord can cause injury if improperly positioned and secured.

- ALWAYS be aware of the location of the hand control cord in relation to the patient and caregivers.
- DO NOT allow the hand control cord to become entangled around the patient and caregivers.
- The hand control must be secured properly. ALWAYS store the hand control properly when not in use.



WARNING!

Risk of Entrapment or Strangulation

Items in the patient's surroundings can cause entrapment strangulation during lifting. To avoid entrapment or strangulation:

- Before lifting, check that the patient is completely free of his/her surroundings.



WARNING!

Risk of Entrapment

There is a risk of entrapment between the spreader bar hooks and the sling.

- Use caution when lifting.
- NEVER put hands or fingers on or near the hooks when lifting.
- Ensure the patient's hands and fingers are away from the hooks before lifting.

IMPORTANT!

All transfer procedures described in the following can be performed by one (1) assistant. However, Invacare recommends that the procedures are performed by two (2) assistants whenever possible.

6.2 Preparing to lift



WARNING!

Risk of Injury

During transfers and lift operation, the boom can impact the patient or caregivers and cause injury.

- ALWAYS be aware of the position of the boom during transfers.
- Ensure the boom is positioned in a way that it cannot impact the patient or bystanders.
- ALWAYS be aware of your body position in relation to the boom during transfers.

1. Before proceeding, review the information and observe all warnings indicated in *2 Safety, page 5* and *Lifting the Patient*.
2. Position the patient onto the sling. Refer to your sling user manual.
3. Unlock the rear castors. See *5 Usage, page 13*.
4. Open the legs of the lift. See *5 Usage, page 13*.
5. Use the push bars to move the patient lift into position.



WARNING!

– When using the lift in conjunction with beds or wheelchairs, be aware of the position of the lift in relationship to those other devices so that the lift does not become entangled.

- Before positioning the legs of the patient lift under a bed, make sure that the area is clear of any obstructions.

6. Lower the patient lift for easy attachment of the sling.
7. Lock the rear castors. See *5 Usage, page 13*
8. Attach the sling. See *Attaching the sling to the lift*

6.2.1 Attaching the sling to the lift



WARNING!
Risk of Injury

Usage of wrong or damaged slings can cause the patient to fall or cause injury to assistants.

- Use an Invacare approved sling that is recommended by the individual's doctor, nurse or medical assistant for the comfort and safety of the individual being lifted.
- Invacare slings and patient lift accessories are specifically designed to be used in conjunction with Invacare patient lifts.
- After each laundering (in accordance with instructions on the sling), inspect sling(s) for wear, tear, and loose stitching.
- Bleached, torn, cut, frayed, or damaged slings are unsafe and could result in injury. Discard immediately.
- DO NOT alter slings.



WARNING!
Risk of Injury

Improperly attached or adjusted slings can cause the patient to fall or cause injury to assistants.

- Be sure to check the sling attachments each time the sling is removed and replaced, to ensure that it is properly attached before the patient is removed from a stationary object (bed, chair or commode).
- The spreader bar **MUST** be attached to the lift **BEFORE** attaching the sling.
- DO NOT use any kind of plastic back incontinence pad or seating cushion between patient and sling material that may cause the patient to slide out of the sling during transfer.
- Make sure that there is sufficient head support when lifting a patient.
- Position the patient in the sling as directed by the instructions provided with the sling.
- Adjustments for patient safety and comfort should be made before moving the patient.

The straps of the sling may be equipped with color coded loops providing different lengths to place the patient into different positions. Shorter straps at the shoulders will produce a more vertical lift, which will assist with positioning into a chair or wheelchair. By lengthening the straps at the shoulders, a more reclined position can be achieved which is more suitable for a chair to bed transfer. Always match the loop colors of the corresponding straps on each side of the sling for an even lift of the patient.

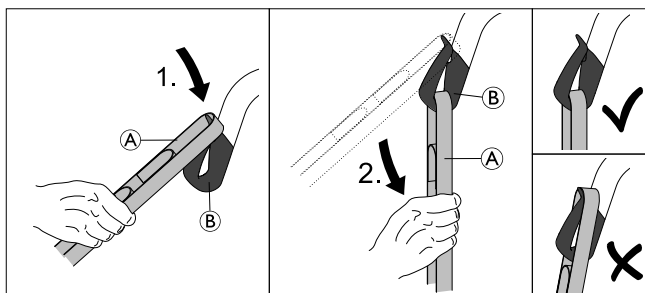

1. Place the desired strap's loop (A) over the nose of hook (B).
2. Pull down the strap (A) until the loop is fully seated at the bottom of hook (B).
3. Repeat the steps for the remaining sling straps (A).



For sling models with six attachment straps, attach the head section straps to the same hooks as the shoulder section straps.

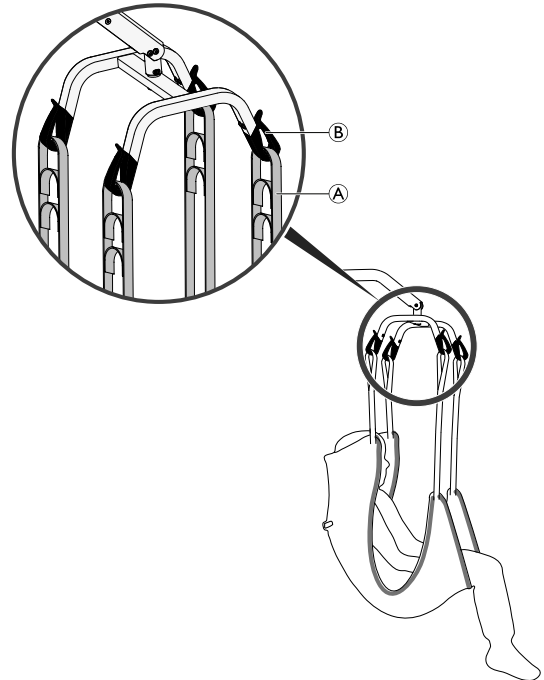

6.3 Transferring a patient from a bed

1. Prepare to lift. See 6.2 *Preparing to lift*, page 16.
2. Attach the sling to the lift. See *Attaching the sling to the lift*.
3. Unlock the rear castors.
- 4.

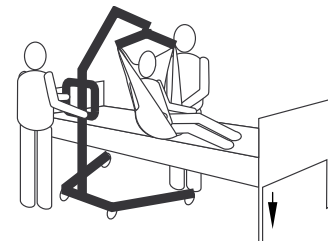

Lower the bed to the lowest position.

5.

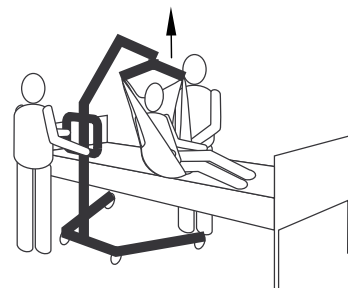

Lift the patient high enough to clear the stationary object with their weight fully supported by the lift.



The boom will stay in position until the DOWN button is pressed.

6.

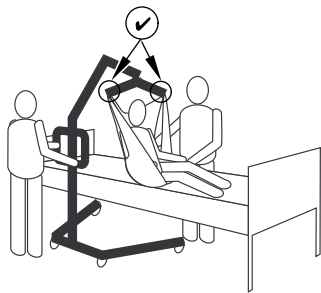

Before moving the patient, check again to make sure that the sling is properly attached to the hooks of the spreader bar. See *Attaching the sling to the lift*. If any attachments are not properly in place, lower the patient back onto the stationary object and correct the problem.

7.

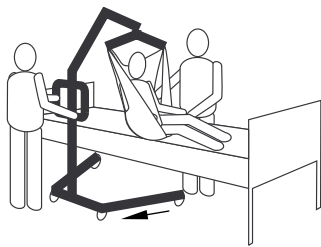

Using the push bars, move the lift away from the stationary object.

8.

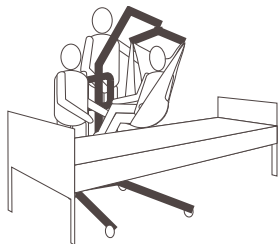

Using the handles on the sling, turn the patient so that he/she faces the assistant operating the patient lift.

9.

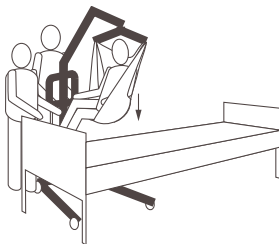

Lower the patient so that his/her feet rest on the base of the lift, straddling the mast.

i The lower center of gravity provides stability making the patient feel more secure and the lift easier to move.

10.

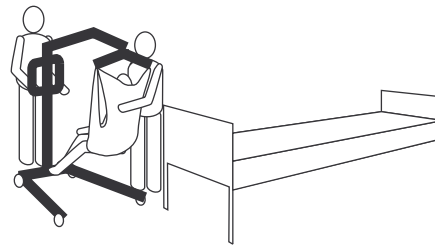

Move the patient lift with both hands firmly on the push bars.

11. Proceed with the transfer to another resting surface or stationary object.

6.4 Transferring a patient to a bed

1. Perform the following steps in addition to those required to lift the patient of another resting surface or stationary object

2.

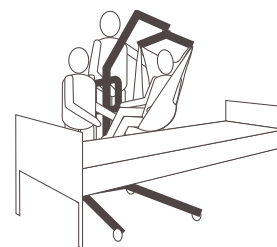

Raise or lower the lift to position the patient over the stationary surface. Be sure to raise or lower the patient enough to clear the sides of the stationary object.

3.



Lower the patient onto the stationary surface.

4. Ensure the patient is fully supported by the surface to which you are transferring.

5. Lock the rear castors.

6. Raise the bed to a good working height (usually hip height of caregivers).

7.

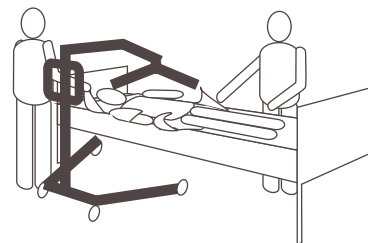

Detach the sling from the spreader bar.

8. Unlock the rear castors.
- 9.

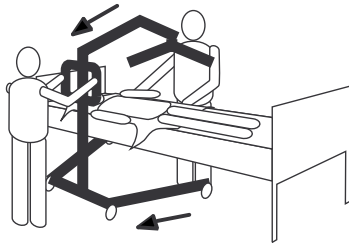

Move the lift away from the area.

6.5 Transferring a patient from a wheelchair

1. Engage the parking brakes of the wheelchair to prevent movement of the wheelchair.
2. Prepare to lift. See 6.2 *Preparing to lift*, page 16.
3. Ensure the wheelchair is placed between the opened legs of the lift with the patient facing the mast.
4. Attach the sling to the lift. See *Attaching the sling to the lift*.
5. Unlock the rear castors.
- 6.

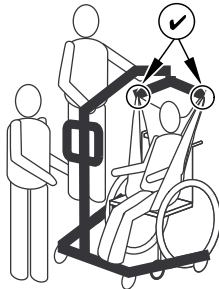

Raise the boom until there is tension on the straps of the sling and make sure that the sling is properly attached to the hooks of the spreader bar. See *Attaching the sling to the lift*. If any attachments are not properly in place, lower the patient back onto the wheelchair and correct the problem.

- 7.

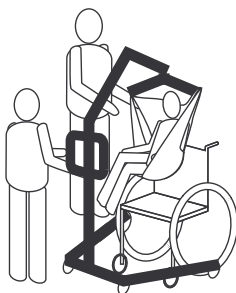

Lift the patient high enough to clear the wheelchair surface with their weight fully supported by the lift.

8. Using the push bars, move the lift away from the wheelchair.
9. Proceed with the transfer to another resting surface or stationary object.

6.6 Transferring a patient to a wheelchair



WARNING! Risk of Injury

- Before transferring, check that the wheelchair weight capacity can withstand the patient's weight.
- The wheelchair wheel locks **MUST** be in a locked position before lowering the patient into the wheelchair for transport.

1. Perform the following steps in addition to those required to lift the patient of another resting surface or stationary object
2. Engage the parking brakes of the wheelchair to prevent movement of the wheelchair.
3. Position the patient over the seat with their back against the back of the chair.
- 4.

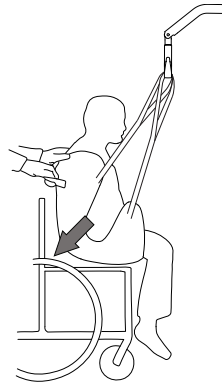

Begin to lower the patient and use the grab handle (on selected models) or sides of the sling to guide the patient's hips as far back as possible into the seat for proper positioning. This will maintain a good center of balance and prevent the chair from tipping forward.

6.7 Transferring a patient to and from a commode



The Invacare patient lift is **NOT** intended as a transport device. If the bathroom facilities are **NOT** near the bed or if the patient lift cannot be easily maneuvered towards the commode, then the patient **MUST** be transferred to a wheelchair and transported to the bathroom facilities before using the patient lift again to position the patient on a standard commode.



The slings with commode openings are designed to be used with either a commode chair or standard commode.



Before transferring the patient, the patient lift should be guided to the bathroom facilities to check that it can be easily maneuvered towards the commode.

1. Perform the following steps in addition to those required to lift the patient of another resting surface or stationary object
- 2.

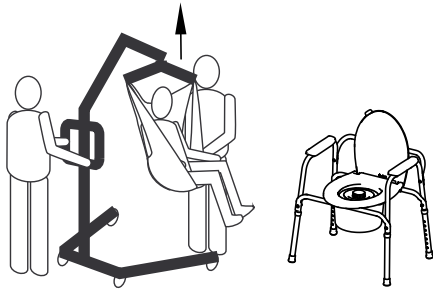

Elevate the patient high enough to clear the commode chair arms and have their weight supported by the patient lift. See 5 Usage, page 13

3.

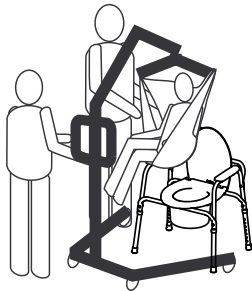

Position the lift so the legs are outside of the commode legs and the push bars of the lift are opposite of the commode and guide the patient over the commode.

4.

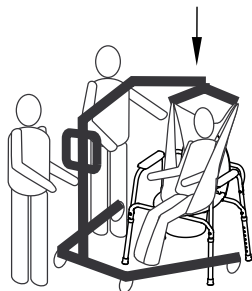

Lower the patient onto the commode, leaving the sling attached to the spreader bar hooks. Invacare recommends that the sling remains connected to the spreader bar hooks during the patient's use of either the commode chair or standard commode.

5.

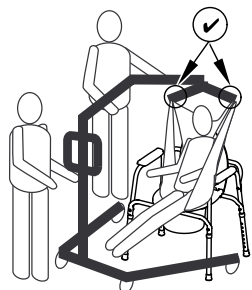

When complete, recheck for correct sling attachment.

6. Raise the patient off of the commode.
- 7.

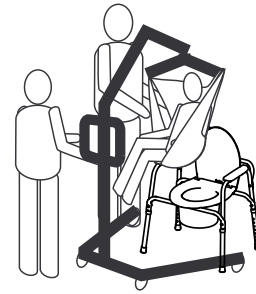

When the patient is clear of the commode surface, use the push bars to move the lift away from the commode.

8. Proceed with the transfer to another resting surface or stationary object.

6.8 Lifting a patient from the floor



WARNING! Risk of Injury

The lift can injure a patient who is on the floor or an assistant working on the floor.

- Always take care when moving parts of the lift close to a person on the floor.

1. Determine if the patient has suffered any injuries from a fall. If no medical attention is needed, proceed with the transfer.
- 2.

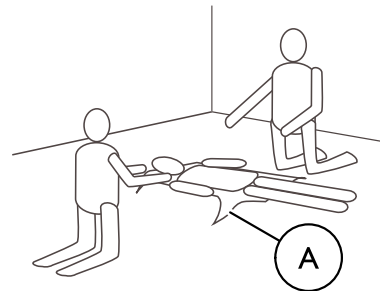

Position the sling **A** under the patient. Refer to the sling user manual for more information about positioning slings.

3.

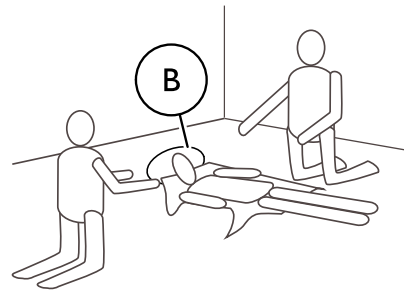

Have the patient bend his/her knees and raise his/her head off of the floor supporting the patient's head with a pillow **B**.

4. Unlock the rear castors. See 5 Usage, page 13
5. Open the legs of the lift. See 5 Usage, page 13

6.

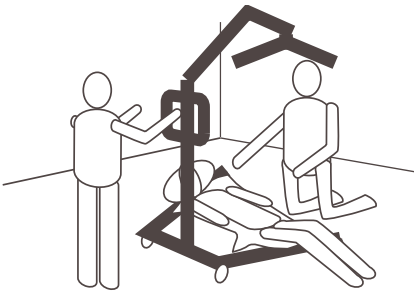

Position the lift with one leg under the patient's bent knees and the other leg under the patient's head. Keep the sling straps inside of the legs of the lift.

7.

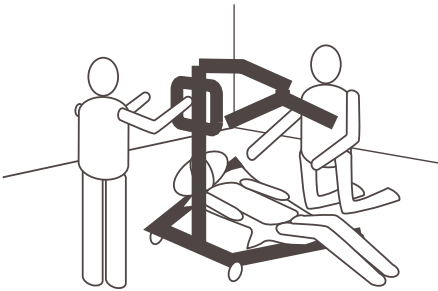

Lower the boom so the spreader bar is directly over the patient's chest.

8.

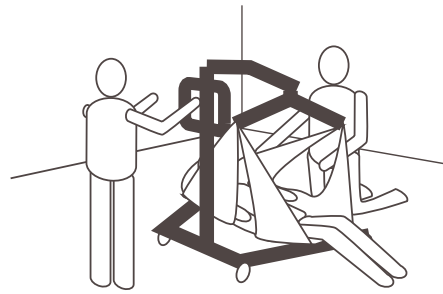

Attach the sling. See *Attaching the sling to the lift*.

9. Raise the boom to lift the patient off the floor.
10. Proceed with the transfer to another resting surface or stationary object.

7 Transportation and Storage

7.1 General information

During transportation, or when the patient lift is not to be used for some time, the emergency stop button should be pushed in.

A folded or disassembled lift can be located in the packaging box, for transportation and storage.

Folded lifts can be pulled on the rear wheels and lifts with a manual leg spreader can be parked in an upright position with the mast/boom assembly pointing upwards.

The patient lift must be stored at normal room temperature. If it is stored in a damp, cold or wet environment then the

motor and other mounting parts may be prone to corrosion. See *Environmental conditions*.

7.2 Folding the mast

1. Using the remote, lower the boom (ensuring the actuator is fully retracted) and narrow both legs completely.
2. Activate the emergency stop button and apply castor brakes.
3. Reverse the procedure described in *Installing the actuator to the boom*.
4. Reverse the procedure described in *Unfolding the spreader bar* (ensure the actuator is fully retracted).
5. Reverse the procedure described in *Unfolding the mast* and pull and hold the safety catch (Ⓔ) upwards before folding down the mast.

8 Maintenance

8.1 General maintenance information

CAUTION!
Risk of injury or damage

- Do not perform any maintenance or service procedures while the product is in use.

Follow the maintenance procedures described in this manual to keep your product in continuous service.

Further maintenance and inspection procedures, to be performed by a qualified technician, are described in the service manual of this product. Service manuals can be obtained from Invacare.

8.2 Daily inspections

WARNING!
Risk of injury or damage

- Damaged or worn parts can affect the safety of the lift.
- The patient lift should be checked each time it is used.
 - Do not use the lift if damage is found or you question the safety of any part of the lift. Contact your Invacare provider immediately and ensure the lift is not used until repairs are made.

Daily Inspection Checklist

- Visually inspect the patient lift. Check all parts for external damage or wear.
- Check all hardware, attachment points and stressed parts, such as slings, hooks and any pivot points for signs of wear, cracking, fraying, deformation or deterioration.
- Verify that the hand control is functional (lifting and leg movements).
- Charge the battery every day the lift is used.
- Check the emergency stop function.
- Check the service light.



The service light is indicated by a wrench symbol on the control unit and if applicable on the hand control.

- If the service light is flashing yellow the lift requires service. Do not use the lift and contact your Invacare provider for service.
- If the service light is not flashing the lift is ready for use.

8.3 Cleaning and Disinfection

8.3.1 General safety information

CAUTION!
Risk of contamination

- Take precautions for yourself and use appropriate protective equipment.

CAUTION!
Risk of electric shock and product damage

- Switch off the device and disconnect from mains, if applicable.
- When cleaning electronic components consider their protection class regarding water ingress.
- Make sure that no water splashes to the plug or the wall outlet.
- Do not touch the power socket with wet hands.

IMPORTANT!

Wrong fluids or methods can harm or damage the product.

- All cleaning agents and disinfectants used must be effective, compatible with one another and must protect the materials they are used to clean.
- Never use corrosive fluids (alkalines, acid etc.) or abrasive cleaning agents. We recommend an ordinary household cleaning agent such as dishwashing liquid, if not specified otherwise in the cleaning instructions.
- Never use a solvent (cellulose thinner, acetone etc.) that changes the structure of the plastic or dissolves the attached labels.
- Always make sure that the product is completely dried before taking into use again.



For cleaning and disinfection in clinical or long-term care environments, follow your in-house procedures.

8.3.2 Cleaning Intervals

IMPORTANT!

Regular cleaning and disinfection enhances smooth operation, increases the service life and prevents contamination.

Clean and disinfect the product

- regularly while it is in use,
- before and after any service procedure,
- when it has been in contact with any body fluids,
- before using it for a new user.

8.3.3 Cleaning instructions

IMPORTANT!

- The product does not tolerate cleaning in automatic washing systems, with high-pressure cleaning equipment or steam.

Cleaning the lift

Method: Wipe off with a damp cloth or soft brush.

Max. temperature: 40 °C

Solvent/chemicals: Ordinary household cleaning agent and water.

Drying: Wipe dry with a soft cloth.

Cleaning the sling

Refer to the washing instructions on the sling and to the sling manual for cleaning details.

8.3.4 Disinfection Instructions

 Information on recommended disinfectants and methods can be found on <https://vah-online.de/en/for-users>.

In Domestic Care

Method: Follow the application notes for the used disinfectant and wipe-disinfect all accessible surfaces.

Disinfectant: Ordinary household disinfectant.

Drying: Allow the product to air-dry.

In Clinical and Long Term Care

Follow your in-house disinfection procedures and only use the disinfectants and methods specified therein.

8.4 Service interval



WARNING!

Risk of injury or damage

Service must be performed only by a qualified technician.

– Contact your Invacare provider for service.

Service must be performed at least every 12 months unless otherwise stated in local requirements.

9 After Use

9.1 Disposal

**WARNING!****Environmental Hazard**

Device contains batteries.

This product may contain substances that could be harmful to the environment if disposed of in places (landfills) that are not appropriate according to legislation.

- DO NOT dispose of batteries in normal household waste.
- DO NOT throw batteries into a fire.
- Batteries MUST be taken to a proper disposal site. The return is required by law and free of charge.
- Only dispose of discharged batteries.
- For information on the battery type see battery label or chapter 11 *Technical Data*, page 27.

Be environmentally responsible and recycle this product through your recycling facility at its end of life.

Disassemble the product and its components, so the different materials can be separated and recycled individually.

The disposal and recycling of used products and packaging must comply with the laws and regulations for waste handling in each country. Contact your local waste management company for information.

9.2 Reconditioning

This product is suitable for reuse. To recondition the product for a new user, carry out the following actions:

- Cleaning and disinfection
- Inspection according to service plan

For detailed information about inspection, cleaning and disinfection, consult the user manual and service manual for this product.

10 Troubleshooting

10.1 Identifying faults and possible solutions

Symptoms	Faults	Solution
Patient lift feels loose.	Mast/ Base joint loose.	Refer to Installing the Mast in the Setup section.
	Tie - Rods are loose.	Contact your Invacare provider.
Castors/ Brakes noisy or stiff.	Fluff or debris in bearings.	Clean castors from fluff and debris.
Noisy or dry sound from pivots.	Pivots are worn or damaged	Contact your Invacare provider.
Electric actuator fails to lift or legs fail to open when button is pressed.	Hand control or actuator connector loose.	Connect hand control or actuator connector. Ensure connectors are seated properly and fully connected.
	Battery low.	Charge the battery. See <i>Charging the battery</i>
	Emergency stop button is pressed in.	Rotate the emergency stop button clockwise until it pops out.
	Battery not connected properly to control unit.	Reconnect the battery to the control unit. See <i>Optional battery charger</i>
	The connecting terminals are damaged.	Contact your Invacare provider.
	Boom or leg actuator is damaged	Contact your Invacare provider.
	Max. load is exceeded	Reduce the load.
Unusual noise from actuator.	Actuator is damaged	Contact your Invacare provider.
Boom will not lower in uppermost position.	Boom requires a minimum weight load to lower from the uppermost position.	Pull down slightly on the boom.
The control unit emits a beeping sound during lifting, and the motor stops.	Max. load is exceeded	Reduce the load (and the lift will function normally).

 Contact your Invacare provider if the above does not solve your problems.

11 Technical Data

11.1 Maximum safe working load

	Birdie® EVO XPLUS
Max. Safe Working Load (patient + spreader bar + sling)	463 lbs

11.2 Dimensions and Weights

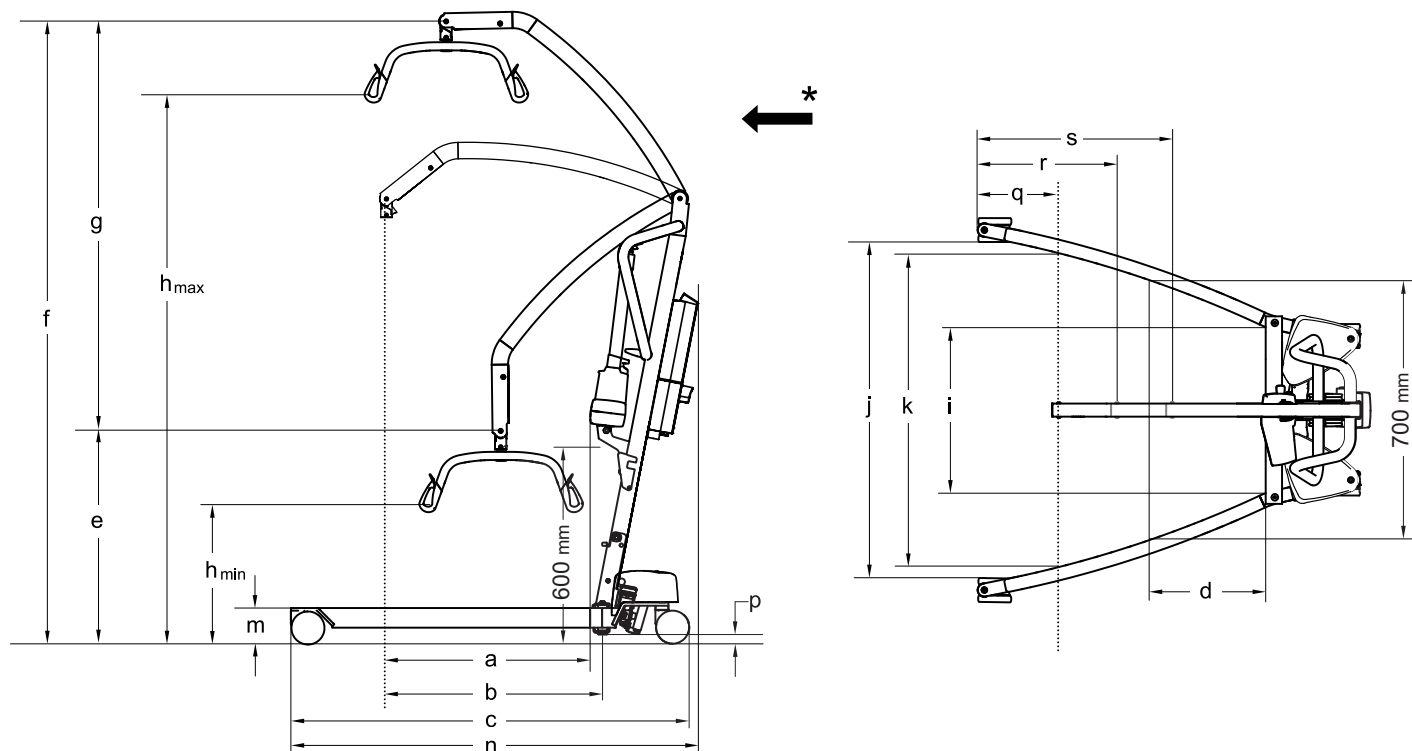

* Forward direction

Dimensions [inches]	Birdie® EVO XPLUS
Front / rear castor diameter	4" / 5"
Max. reach at 600 mm = 23 5/8" (a)	24 3/4"
Max. reach from base (b)	24 3/4"
Base length (c)	50 3/8"
Total length (n)	50 3/8"
Reach from base with legs spread to 700 mm = 27 1/2" (d)	8 7/8"
CSP* min. height / lowest position (e)	32 7/8"
CSP* max. height (f)	83"
Lifting range (g)	50 1/8"
Min. height at Sling Hook-up (h _{min})	23 7/8"
Max. height at Sling Hook-up (h _{max})	74"
Total width (legs open) centre to centre of castor	43 1/4"
Total width (legs open) internal measure (j)	40 1/8"
Total width (legs closed), external measure	25 1/4"
Min. internal width (i)	19 1/2"

Dimensions [inches]	Birdie® EVO XPLUS
Internal width at maximum reach (k)	37 3/4"
Turning diameter	56 1/4"
Height to upper edge of legs (m)	4 1/2"
Min. free height (p)	1 3/8"
Minimum distance from wall to CSP* at maximum reach (legs open) (q)	10"
Minimum distance from wall to CSP* at maximum height (legs open) (r)	25 7/8"
Minimum distance from wall to CSP* at minimum height (legs open) (s)	16 7/8"
Height when folded	18 1/2"
Length when folded	53 1/2"

* CSP = Central Suspension Point



All measures are taken with a 19 5/8" 4 - point spreader bar.

Weights Main Parts [lbs]	Birdie® EVO XPLUS
Total weight excl. spreader bar	90
Weight, mast, incl. battery, excl. spreader bar	42
Weight electrical base	49

Weight Spreader Bar [lbs]	
Spreader bar, 4 - point, 19 5/8"	6.4

11.3 Electrical System

	Birdie® EVO XPLUS
Voltage output	24 V DC, max. 250 VA
Voltage supply	100 – 240 V AC, 50/60 Hz
Maximum current input	400 mA
Protection class (entire device)	IPX4*
Insulation class	Class II equipment
Type B Applied Part	Applied part complying with the specified requirements for protection against electrical shock according to IEC60601-1.
Sound level	45 – 50 dB(A)
Working ability	40 full lifts (with battery between 100% – 50% of full capacity)
Intermittent (periodic motor operation)	10%, max. 2 min/18 min
Battery specifications	2 x 12 V / 2.9 Ah
Battery type	Lead acid (service free, sealed)
Manual emergency lowering	Yes (at bottom of actuator)
Electric emergency lowering / lifting	Yes / Yes
Battery Charger's Power Consumption	while charging: max. 19 W in standby: max. 2.5 W
Lifting Speed - without load	1 7/8 in/s
Lifting Speed - with 176 lbs person	1 5/8 in/s

*IPx4 - The system is protected against water splashed from any direction.

11.4 Environmental Conditions

	Storage and transportation	Operation
Temperature	14 °F to 122 °F	41 °F to 104 °F
Relative humidity	20% to 90% at 86 °F, not condensing	
Atmospheric pressure	11.6 psi to 15.4 psi	

-  Allow the product to reach operation temperature before usage:
- Warming up from minimum storage temperature might take more than 30 minutes.
 - Cooling down from maximum storage temperature might take more than 5 minutes.

11.5 Materials

Component	Material
Base, legs, mast and boom	Steel, powder-coated
Spreader bar	Steel, powder-coated and TPU
Actuator housing, hand control, mast protector, castors and other plastic parts	Material according to marking (PA, PP, PE)
Boom connector, bolts and nuts	Steel, zinc-plated

All components of the product are either corrosion resistant or corrosion protected.

11.6 Operating Forces of Controls

Control	Operating force
Buttons on control unit	1 lbs
Buttons on hand control	1 lbs

12 Electromagnetic compatibility (EMC)

12.1 General EMC information

Medical Electrical Equipment needs to be installed and used according to the EMC information in this manual.

This product has been tested and found to comply with EMC limits specified by IEC/EN 60601-1-2 for Class B equipment.

Portable and mobile RF communications equipment can affect the operation of this product.

Other devices may experience interference from even the low levels of electromagnetic emissions permitted by the above standard. To determine if the emission from this product is causing the interference, run and stop running this product. If the interference with the other device operation stops, then this product is causing the interference. In such rare cases, interference may be reduced or corrected by the following:

- Reposition, relocate, or increase the separation between the devices.

12.2 Electromagnetic emission

Guidance and manufacturer's declaration

This product is intended for use in the electromagnetic environment specified below. The customer or the user of this product should assure that it is used in such an environment.

Emissions test	Compliance	Electromagnetic environment - guidance
RF emissions CISPR 11	Group I	This product uses RF energy only for its internal function. Therefore, its RF emissions are very low and are not likely to cause any interference in nearby electronic equipment.
RF emissions CISPR 11	Class B	This product is suitable for use in all establishments including domestic establishments and those directly connected to the public low-voltage power supply network that supplies buildings used for domestic purposes.
Harmonic emissions IEC 61000-3-2	Class A	
Voltage fluctuations /flicker emissions IEC 61000-3-3	Complies	

12.3 Electromagnetic Immunity

Guidance and manufacturer's declaration

This product is intended for use in the electromagnetic environment specified below. The customer or the user of this product should assure that it is used in such an environment.

Immunity test	Test / Compliance level	Electromagnetic environment – guidance
Electrostatic discharge (ESD) IEC 61000-4-2	± 8 kV contact ± 2 kV, ± 4 kV, ± 8 kV, ± 15 kV air	Floors should be wood, concrete or ceramic tile. If floors are covered with synthetic material, the relative humidity should be at least 30 %.
Electrostatic transient / burst IEC 61000-4-4	± 2 kV for power supply lines; 100 kHz repetition frequency ± 1 kV for input / output lines; 100 kHz repetition frequency	Mains power quality should be that of a typical commercial or hospital environment.
Surge IEC 61000-4-5	± 1 kV line to line ± 2 kV line to earth	Mains power quality should be that of a typical commercial or hospital environment.

Immunity test	Test / Compliance level	Electromagnetic environment – guidance
Voltage dips, short interruptions and voltage variations on power supply input lines IEC 61000-4-11	< 0% U_T for 0,5 cycle at 45° steps 0% U_T for 1 cycles 70% U_T for 25 / 30 cycles < 5% U_T for 250 / 300 cycles	Mains power quality should be that of a typical commercial or hospital environment. If the user of this product requires continued operation during power mains interruptions, it is recommended that the product is powered from an un-interruptible power supply or a battery. U_T is the a. c. mains voltage prior to application of the test level.
Power frequency (50/60 Hz) magnetic field IEC 61000-4-8	30 A/m	Power frequency magnetic fields should be at levels characteristic of a typical location in a typical commercial or hospital environment.
Conducted RF IEC 61000-4-6	3 V 150 kHz to 80 Mhz 6 V in ISM & amateur radio bands	Field strengths from fixed transmitters, such as base stations for radio (cellular/cordless) telephones and land mobile radios, amateur radio, AM and FM radio broadcast and TV broadcast cannot be predicted theoretically with accuracy. To assess the electromagnetic environment due to fixed RF transmitters, an electromagnetic site survey should be considered. If the measured field strength in the location in which this product is used exceeds the applicable RF compliance level above, this product should be observed to verify normal operation. If abnormal performance is observed, additional measures may be necessary, such as reorienting or relocating this product. Interference may occur in the vicinity of equipment marked with the following symbol: 
Radiated RF IEC 61000-4-3	10 V/m 80 Mhz to 2,7 GHz 385 MHz - 5785 MHz test specifications for immunity to RF wireless communication equipment refer to table 9 of IEC 60601-1-2:2014	Portable and mobile RF communications equipment should be used no closer than 30 cm to any part of this product including cables.

 These guidelines may not apply in all situations. Electromagnetic propagation is affected by absorption and reflection from structures, objects and people.



USA:

Invacare Corporation
One Invacare Way
Elyria, Ohio USA
44035
800-333-6900
www.invacare.com



Invacare Portugal, Lda
Rua Estrada Velha 949
4465-784 Leça do Balio
Portugal

60127406-C 2021-11-10



Making Life's Experiences Possible®



Yes, you can.®